

# Data Sheet



Article number: 021500700087

Description: Sealing Clamp S 87 W5

## Measures

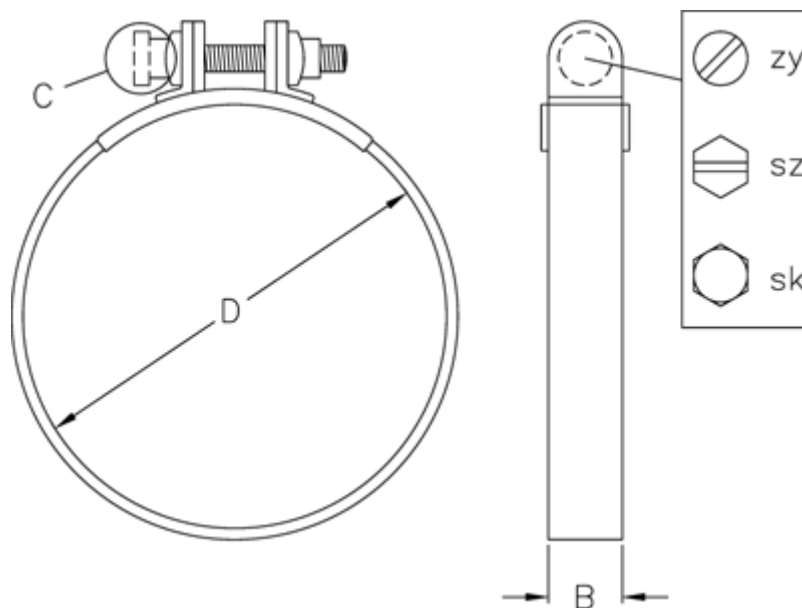

C (screw type) = SZ

Diameter D = 87

Width B = 20